

ZLAN5840I

Isolation 8 Ports Serial Device Server/ Modbus Gateway

User Manual

8 ports RS485 to TCP/IP converter

Copyright©2008 Shanghai ZLAN Information Technology Co., Ltd. All right reserved

Document DI: ZL DUI 20180611.1.0



Version Information

The History of the revision to this document:

			History
Date	Version	Document ID	Revising content
2019-6-11	Rev.1	ZL DUI 20180611.1.0	Release

Copyright information

Information in this document is subject to change without notice. It is against the law to copy the document on any medium except as specifically allowed in the license or nondisclosure agreement. The purchaser may make one copy of the document for backup purposes. No part of this manual may be reproduced or transmitted in any form or by any means, electronic or mechanical, including photocopying, recording, or through information storage and retrieval systems, for any purpose other than for the purchaser's personal use, without the express written permission of Shanghai ZLAN information Technology Co., Ltd.

Contents

1.	Summary.....	4
2.	Features.....	5
2.1	Hardware Features.....	5
2.2	Software Functions.....	6
3.	Technical parameter.....	7
4.	Hardware description.....	7
5.	Usage.....	9
5.1	Usage Overview.....	9
5.2	Software Installation.....	10
5.3	Parameter Configuration.....	11
5.4	TCP communication test.....	17
5.5	Virtual serial port test.....	19
5.6	Modbus TCP test.....	22
6.	Work Mode and Transfer Protocol.....	23
6.1	Virtual Serial Mode.....	25
6.2	Direct TCP/IP Communication Mode.....	25
6.2.1	TCP Client Mode.....	26
6.2.2	TCP Server Mode.....	27
6.2.3	UDP Mode.....	28
6.3	Device Pairs-connect Mode.....	28
7.	Device Debugging.....	30
7.1	Network Physical Connection.....	30
7.2	Network TCP Connection.....	30
7.3	Data Sending and Receiving.....	31
7.4	ZLVircom Remotely Monitor Data.....	32
8.	Modbus Advanced Features.....	33
8.1	Enable Modbus Gateway.....	34
8.2	Multi-host Function.....	34
8.3	Multi-host Parameter.....	36
9.	Network Interface to Modify Parameters.....	37
10.	Device Management Function Library.....	38
11.	Serial Port Modify Parameters.....	38
12.	Remote device management.....	39
13.	Cascade Method.....	41
14.	Installation Size.....	42
15.	After-service and technical support.....	42

1. Summary

ZLAN5840I is the new generation RS485 isolated 8-port server /Modbus gateway developed by Shanghai ZLAN information technology Co., LTD. It can effectively isolate the influence of RS485 bus interference on the operation of the device and ensure the stability of the device. Suitable for RS485 bus interference environment. Built-in power surge protection.

ZLAN5840I can realize 8-way serial port data to TCP/IP. Compared with ZLAN5800A, ZLAN5840I supports Modbus gateway function from Modbus TCP to Modbus RTU. Modbus gateway supports simultaneous reading of data on multiple Modbus clients, which is called "multi-host" function.

ZLAN5840I support 8 RS485 serial ports, and RS485 interface is a terminal interface. Two 10M/100M Ethernet ports are supported. The user connects the device to the network through a network cable. The upper computer can access 8 serial ports simultaneously through virtual serial ports or TCP protocol.

ZLAN5840I supports 16 serial ports, 24 serial ports, 32 serial ports and up to 64 serial ports.



Figure 1 ZLAN58401

Can be applied to:

- 1) Power electronics, intelligent instruments and energy consumption monitoring;
- 2) As the gateway of Internet of things and the communication bridge between devices and cloud;
- 3) All kinds of automation PLC remote monitoring and program download;
- 4) All kinds of configuration software and equipment communication interface;
- 5) Networking of access control and security equipment;
- 6) Collection of networking information of medical devices;

2. Features

2.1 Hardware Features

- 1) 8 serial ports support photoelectric isolation RS485 serial ports.
- 2) 8 serial ports can work independently without interference and can be configured for different baud rates.
- 3) Support network switch function of 2 network ports, can be used as switch at the same time.
- 4) Abundant indicator light, each serial port has a separate TCP connection indicator light and data activity indicator light.

2.2 Software Functions

- 1) Support TCP server, TCP client, UDP mode, UDP multicast. Supports 10 TCP connections as a TCP server.
- 2) Baud rate support 1200~460800bps, data bit support 5~9 bit, check bit can be none, odd check, even check, mark, space five ways.
- 3) Support device connection to send MAC address function, convenient cloud management device.
- 4) Provide computer terminal search, configuration equipment secondary development kit DLL development library.
- 5) Support DHCP dynamic access to IP, DNS protocol connection domain name server address.
- 6) Support cloud remote search device, device parameters configuration.
- 7) Support remote view of device TCP connection status via software. Virtual serial port support data monitoring function.
- 8) Support Modbus gateway function, support Modbus RTU to Modbus TCP.
- 9) Support multi-host function: in the question and answer query mode, support network port allows more than one computer access to the same serial port device.

3. Technical parameter

Interface:	RS485: 8 terminal; 2 RJ45 port		
Power Supply:	5.5mm, Inside positive outside negative, standard outlet; Terminal		
Size:	L x W x H = 27mm×10.5mm×2.6mm		
Communicate Interface			
Ethernet:	10M/100M, anyone can work, 2KV surge protection		
Serial	RS485×8 : 485A, 485B, GND		
Serial Parameters			
Baud rate:	1200~460800bps	Parity:	None, Odd, Even, Mark, Space
Data size:	5~9	Flow control:	RTS/CTS, DTR/DCT, NONE
Software			
protocol:	ETHERNET、IP、TCP、UDP、HTTP、ARP、ICMP、DHCP、DNS		
Setting method :	ZLVirCom, WEB browser, device management library		
Communication method:	Socket, Virtual serial, DLL		
Work Mode			
TCP server, TCP client, UDP, UDP multicast			
Power			
Power:	9 ~ 24V DC, 5.4W		
Environment			
Running temperature:	-40~85℃		
Storage temp:	-65~165℃		
Humidity:	5~95%RH		

4. Hardware description

The front view of ZLAN5840I is shown as FIG. 2.

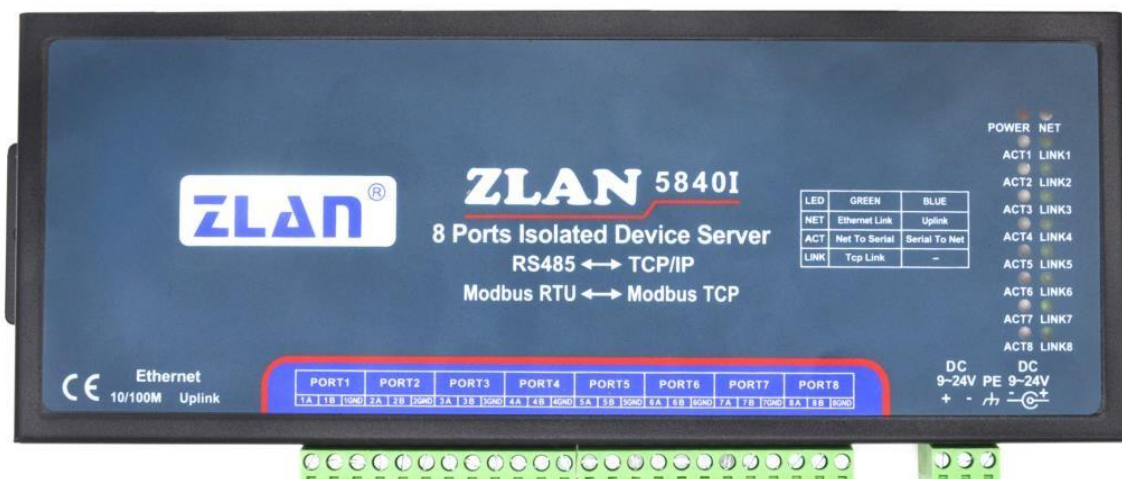

Figure 2 ZLAN5840I Front View

- 1) **Size:** L x W x H =27cm×10.5cm×2.6cm
- 2) **Installation method:** it can be installed on the back plate through the "hanging ear" on both sides. In addition, it can also be equipped with guide rail accessories and installed on the guide rail.
- 3) **Power supply:** standard power adapter (with a positive core of 5.5mm) or power terminal can be used, as shown in figure 2. The supply voltage can be 9 ~ 24V. The power supply current is required to be greater than 600mA. PE is grounded for the enclosure and can be connected as needed.
- 4) **Ethernet port:**
 - a) Ordinary network port (10/100M) : the user connect ZLAN5840I to the switch, hub or directly to the computer network card through the network port.
 - b) Cascade network port (Uplink) : used for cascade of ZLAN5840I, refer to the description of cascade section of this document.
- 5) **Indicator:**
 - a) Data forwarding indicator ACT (blue and green) : when the ACT light is green, it means that data is normally transmitted between Ethernet and corresponding serial port; when the ACT light is blue, it means that data is normally transmitted from serial port to Ethernet; when there is no data

communication, the ACT light will not be on. When debugging RS485 bus, whether the ACT is blue or not can be used to determine whether the RS485 device has data return.

- b) TCP connection setup indicator LINK (green) : the LINK light indicates that the current corresponding serial TCP connection has been established and can normally send and receive data.
- c) Power indicator PWR (red): indicates that the serial server is powered up.
- d) Network indicator NET: orange means the ordinary network port (not cascade network port) network cable has been connected;

Network indicator NET: blue indicates that the cascade network cable has been connected.

- 6) RS485 serial port: ZLAN5840I conforms to RS485 standard, and each ZLAN5840I can carry 32 terminal 485 devices. Each RS485 with GND line, can be connected according to the need.

5. Usage

5.1 Usage Overview

After installing ZLVircom, you can manage the device.

Power the ZLAN5840I and connect the network cable to the ordinary network port of ZLAN5840I. Use ZLVircom software, the device management can see the interface shown in figure 3.



序	类型	设备名称	设备IP	目的IP	模式	TCP连接	虚拟串口号	虚拟串口...	设备ID
1	内网	ZLDEV0006	192.168.1.206	192.168.1.3	TCP Server	未建立	未设置	未联通	AD5E8E02
2	内网	ZLDEV0005	192.168.1.205	192.168.1.3	TCP Server	未建立	未设置	未联通	AD676590
3	内网	ZLDEV0003	192.168.1.203	192.168.1.3	TCP Server	未建立	未设置	未联通	AD5D8E31
4	内网	ZLDEV0008	192.168.1.208	192.168.1.3	TCP Server	未建立	未设置	未联通	AD4F8EEF
5	内网	ZLDEV0007	192.168.1.207	192.168.1.3	TCP Server	未建立	未设置	未联通	AD4D8EC1
6	内网	ZLDEV0004	192.168.1.204	192.168.1.3	TCP Server	未建立	未设置	未联通	AD6665BB
7	内网	ZLDEV0001	192.168.1.201	192.168.1.3	TCP Server	未建立	未设置	未联通	AD558E39
8	内网	ZLDEV0002	192.168.1.202	192.168.1.3	TCP Server	未建立	未设置	未联通	AD568E0A

Figure 3 ZLAN5840I found by ZLVircom

The 8 lines here correspond to the 8 serial ports inside ZLAN5840I respectively. When leaving the factory, the IP addresses corresponding to the serial ports 1~8 of ZLAN5840I are 192.168.1.201 ~ 192.168.1.208. Double-click a row to configure and edit the parameters of the port. Usage details are described in detail in the following sections.

5.2 Software Installation

ZLVircom can be used to configure the device IP and other parameters, also can create virtual serial port. If no need the virtual serial port function, you can download the free-installation version.

Table 1 ZLVircom Version

Software	Description
ZLVircom Device Management Tool (free-installation version)	This version no have the virtual serial port function
ZLVircom Device Management Tool (installation version)	This version has the ZLVircom_x64.msi and ZLVircom_x86.msi. The 64 bit operating system install x64, 32 bit system install x86 version.

Just follow the default prompt when installing. Upon completion of the installation, ZLVircom will be started each time the computer is started, which is used to boot up to create a virtual serial port.

5.3 Parameter Configuration

After installing ZLVircom, the hardware also connecting, run ZLVircom software as figure 4, and click "Device Manage" as figure 5. Use ZLVircom can search and configure the device parameter in different segment, which is very convenient as long as the device and computer of running ZLVircom are under the same switch.

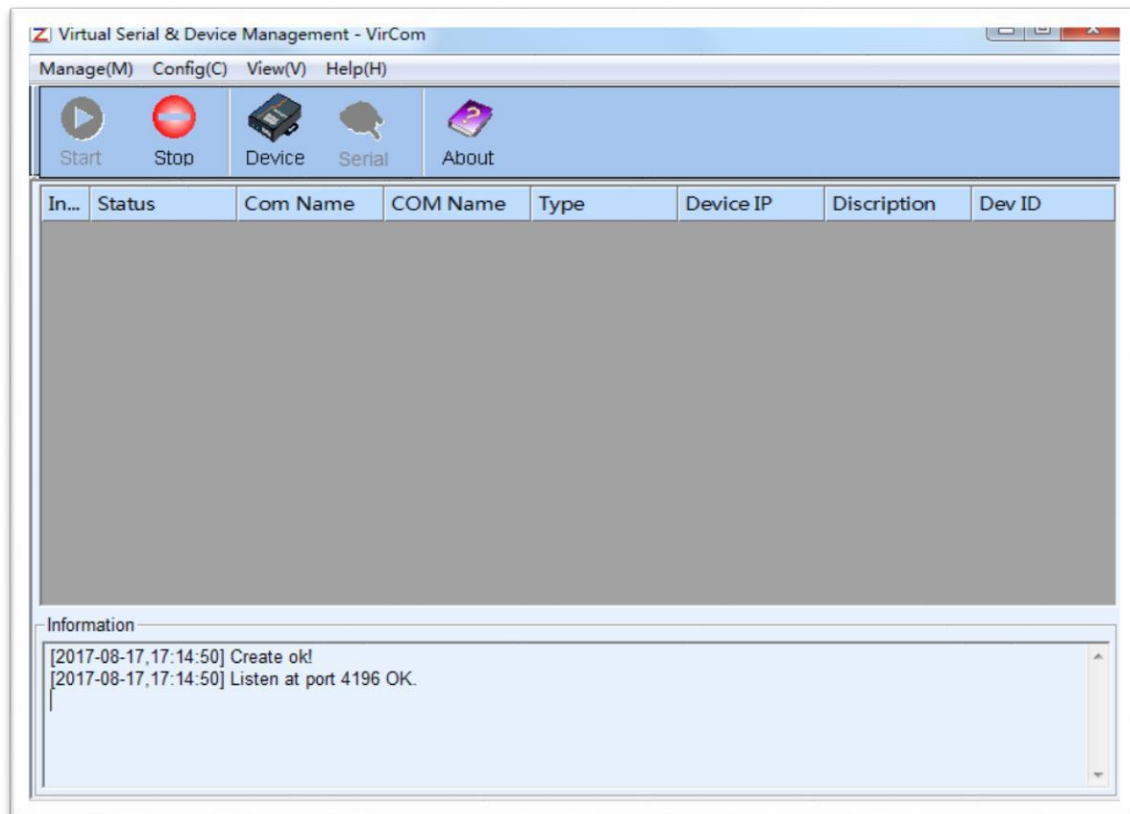

Figure 4 ZLVircom Main Interface

In...	Ty...	Name	Dev IP	Dest IP	Work M...	TCP ...	Virtual ...	Vircom St...	Dev ID	TXD	RXD
1	Su...	90长期测	192.168.1.63	119.90.51.5	TCP Ser...	Not E...	Haven't ...	Not Linked	2F3D333B	0	0
2	Su...	p2p	192.168.1.188	192.168.1.3	TCP Ser...	Not E...	Haven't ...	Not Linked	4053C85B	0	0
3	Su...	开发板p2p	192.168.1.222	192.168.10.1...	TCP Ser...	Not E...	Haven't ...	Not Linked	40AEA571	111	0
4	Su...	40长期测	192.168.1.248	119.90.51.5	TCP Ser...	Not E...	Haven't ...	Not Linked	A3EF280C	0	0
5	Su...	6842	192.168.1.250	192.168.1.102	TCP Ser...	Not E...	Haven't ...	Not Linked	C9589C2B	0	0

Buttons on the right: Auto Search, Add Manually, Search Serial, P2P Device, Edit Device, Search List, Back

Figure 5 Device List

From the device list, you can see all of the current online devices, and you can search for devices that are not in one network segment. There is no need to use the "Add Manually" function.

Click the "Edit Device" to configure the device parameters.

Device Settings

Device Info

- Virtual Serial: Not Use
- Dev Type: ZLSN2042
- Dev Name: 6842
- Dev ID: 284FC9589C2B
- Firmware Ver: V1.597

Function of the device

- Web Download
- DNS System
- REAL_COM Protocol
- Modbus TCP To RTU
- Serial Commnad
- DHCP Support
- Storage Extend
- Multi-TCP Connection

Network

- IP Mode: Static
- IP Address: 192 . 168 . 1 . 250
- Port: 502
- Work Mode: TCP Server
- Net Mask: 255 . 255 . 255 . 0
- Gateway: 192 . 168 . 1 . 1
- Dest. IP/Domain: 192.168.1.149 Local IP
- Dest. Port: 1024

Serial

- Baud Rate: 115200
- Data Bits: 8
- Parity: None
- Stop Bits: 1
- Flow Control: None

Advanced Settings

- DNS Server IP: 8 . 8 . 4 . 4
- Dest. Mode: Dynamic
- Transfer Protocol: Modbus_TCP Protocol
- Keep Alive Time: 10 (s)
- Reconnet Time: 12 (s)
- Http Port: 80
- UDP Group IP: 230 . 90 . 76 . 1
- Register Pkt: ASCII
- Restart for no data every 50 Sec.
- Enable send parameter every 5 Min.

Framing Rule

- Max Frame Length: 1300 (Byte)
- Max Interval(Smaller will better) 3 (Ms)

Buttons: Get Default, Save As Default, Load Default, Modify Key, Load Firmware, Restart Dev, Modify Setting, Cancel

Figure 6 Device Parameters

In this interface, the user can set the parameters of the device, then click "Modify Setting", and the parameters are set to the flash of the device, with power-off no lost. The device will restart automatically.

The main configuration parameters are: baud rate, data bit, and check bit in serial port setting; IP address, subnet mask, gateway in network setting; Sometimes you need to configure the work mode of the serial port server according to the computer software.

The meaning of the parameters is described as follows:

Table 2 Parameter Meaning

Parameter Name	Value Range	Instruction
Virtual Serial	Non-in use, created virtual serial port	You can bind the current device to a created virtual serial port.
Dev Type		Show only the model of the core module
Dev Name	Any	You can give the device a readable name, with a maximum of 9 bytes, and support the Chinese name.
Dev ID		The factory's sole ID, cannot be modified.
Firmware Version		The firmware version of core module
Supporting Function		Please refer to the Table 4 "support functions"
IP Mode	Static, DHCP	The user can choose Static or DHCP (Dynamic acquisition of IP)
IP Address		The IP Address of networking products
Port	0~65535	The monitoring port of Networking products when in the TCP Server or UDP mode. As a client, it is best to specify that the port is port 0, which is good for increasing the connection speed, and the system will randomly assign a local port when using the 0 port. At this time the difference from specifying the non-zero port are: (1) local port is 0, module sets up a new TCP connection with PC when restarting, old TCP connection may not be closed, so that the old TCP connection of the host has been unable to close, specify the non-zero port does not have the problem.

		Generally host wants to close the old connection when the module is restarted. (2) the local port is 0, the time of TCP rebuilding connection is faster.
Work Mode	TCP Server(TCP Server Mode),TCP Client(TCP Client Mode),UDP Mode, UDP Multicast	When set to TCP Server, the network Server needs to actively connect the networking products; When set to TCP Client, the networking product initiates the connection to the network server specified by the destination IP.
Net Mask	Eg: 255.255.255.0	Must be same as net mask of local LAN.
Gateway	Eg: 192.168.1.1	Must be the same as the local LAN gateway. If it is not crossing outer network (such as the cable connecting computer), it is best to set the gateway as the IP address of the connected computer.
Dest. IP/Domain		In the TCP Client or UDP mode, the data will be sent to the destination IP or the computer of domain name instruction.
Dest. Port		In the TCP Client or UDP mode, the data is sent to the destination port of the destination IP.
Baud Rate	1200, 2400, 4800, 7200, 9600, 14400, 19200, 28800, 38400, 57600, 76800, 115200, 230400, 460800	Serial baud rate
Data Bits	5, 6, 7, 8, 9	
Parity	None, Even, Odd, Mark, Space	
Stop Bits	1, 2	
Flow Control	None (no flow control), CTS/RTS, DTR/DCR, XON/XOFF	RS232 port valid
DNS Server IP		When the destination computer is described by a domain name, DNS server is required to resolve the domain name, which specifies the IP of this DNS server. When the IP mode is DHCP, the parameter is not specified and will be automatically acquired.
Dest. Mode	Static, Dynamic	UDP working mode: if the destination computer is described by a domain name, it's best to choose the static mode; If there are multiple computers in the LAN communicating with networking products through UDP, it is best to choose dynamic mode.

		<p>TCP server mode: this parameter must be dynamic.</p> <p>TCP client mode: when IP mode is dynamic, the destination IP is reconnected after the device is restarted, so that the correct IP address can be obtained again. Otherwise, it will do direct connection without automatically restarting the device.</p>
Transfer Protocol	NONE, Modbus TCP<->RTU, Real_COM	NONE indicates that the data forwarding from the serial port to the network is transparent; Modbus TCP<->RTU will convert Modbus TCP protocol directly into RTU protocol to facilitate coordination with Modbus TCP protocol; RealCOM is designed to be compatible with the old version of REAL_COM.
Keep Active Time	0~255	<p>(1) Choose 1~255, if the device is in the TCP client working mode, the TCP heartbeat will be sent automatically for every "keep alive time". This can guarantee the TCP availability of links. When set to 0, there will be no TCP heartbeat.</p> <p>(2) Set to 0~254, when transformation protocol choose REAL_COM protocol, the device will send a length of 0 to 1 content data for every " keep alive time " to implement the heartbeat mechanism of Realcom. When set to 255, there will be no Realcom heartbeat.</p> <p>(3) Set to 0~254, if the device is working on the TCP client, the device will send the parameters to the destination computer every " keep alive time ". When set to 255, no have the parameter sending function. This mechanism is not normally used, users are not required to pay attention.</p>
Reconnect Time	0~255	Once the networking products in a TCP client mode disconnect with the server (as long as in the non-connection status), it will initiates a TCP connection to the Server every while, can be 0~254 seconds, if set 255, never for reconnection. Note first TCP connection would immediately (such as hardware on electricity, through zlvircom software restart equipment, no data), only after the first connection failure will try again after waiting for the "break time", so "break time" will not affect the network and server connection setup time under normal circumstances.
Http Port	1~65535	
UDP Group		UDP multicast

IP		
Max Frame Length	1~1400	One of the rules of serial. The connected product serial port sends the received data to the network as a frame after receiving the length data.
Max Interval (Smaller will better)	0~255	One of the rules of serial. When there is a pause in the data received by the connected product, and the pause time is greater than that time, the received data is sent to the network as a frame.

The functions supported by the device are explained as follows:

Table 3 Device Supported Function

Name	Instruction
Webpage download	Support to control the serial output command through the web page, only the product with the trailing W has this function.
Domain name system	The destination IP can be the domain name (such as the beginning of the WWW server address).
REAL_COM protocol	It is a non-transparent transmission serial device server protocol, which is suitable for the binding of virtual serial port through Internet. Because the protocol contains the device MAC address, it is helpful for the upper computer to identify the device. In general, it can be without use.
Modbus TCP to RTU	Only the models that the third bit is 4 support this function. Modbus TCP to RTU can be implemented. It also supports multi-host capabilities.
Serial port modify parameters	The serial port modification parameter supports the serial port AT instruction to configure and read the device parameters.
Automatic acquisition of IP	Support for DHCP client protocol
Storage extension EX function	Extended later
Multiple TCP connections	Support more than one TCP connections as a TCP server.
IO port control	Model No. 3 of 4 supports arbitrary custom instructions to control 8 IO outputs.
UDP multicast	UDP multicast

Multi-destination IP	As a TCP client supports simultaneous connection of 7 destination IP.
Proxy server	Support the proxy server functionality (a specific model is required).
SNMP function	Support SNMP to Modbus RTU protocol. Only those with -snmp tails support this feature.
P2 function	Support the ability to access devices in any network through P2P across technology. This feature is supported in model N with trailing patches.

5.4 TCP communication test

After the device parameters are configured, TCP connection communication can be tested with serial port tools and TCP debugging tools.

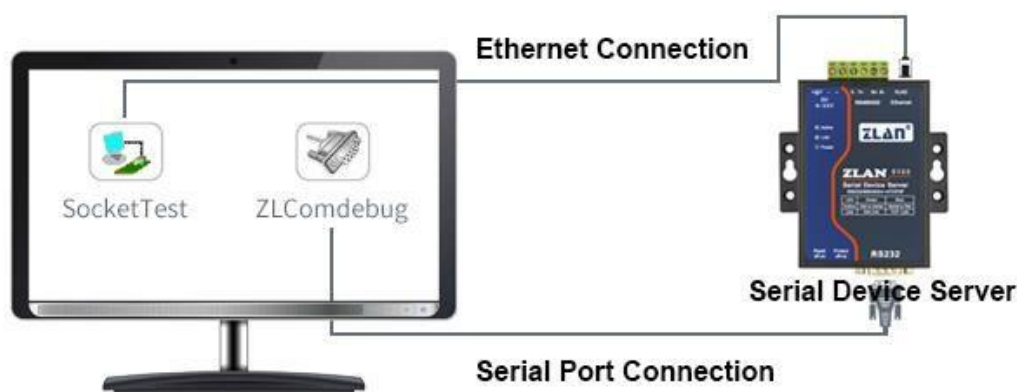

Figure 7 TCP communication diagram

Now suppose the PC COM port (USB to RS232 line) connect with serial port of serial device server, then open the serial debugging assistant ZLComDebug, and open the corresponding COM as figure 8; Open TCP&UDP debugging assistant SocketTest, and as TCP client, fill in the destination IP for the serial port server IP (currently 192.168.1.200), destination port is 4196, and then click "open" button in figure 9. Enter "socket send" in SocketTest and click send, then the data is transferred to RS232 interface through the network port of the serial port server, and then sent to ZLComDebug, which is then displayed in ZLComDebug. Conversely, type "Comdebug send" in ZLComDebug, and clicking send can also be sent to socket test and displayed.

The demonstration demonstrates the data transparent forwarding function from serial port to network port, network port to serial port.

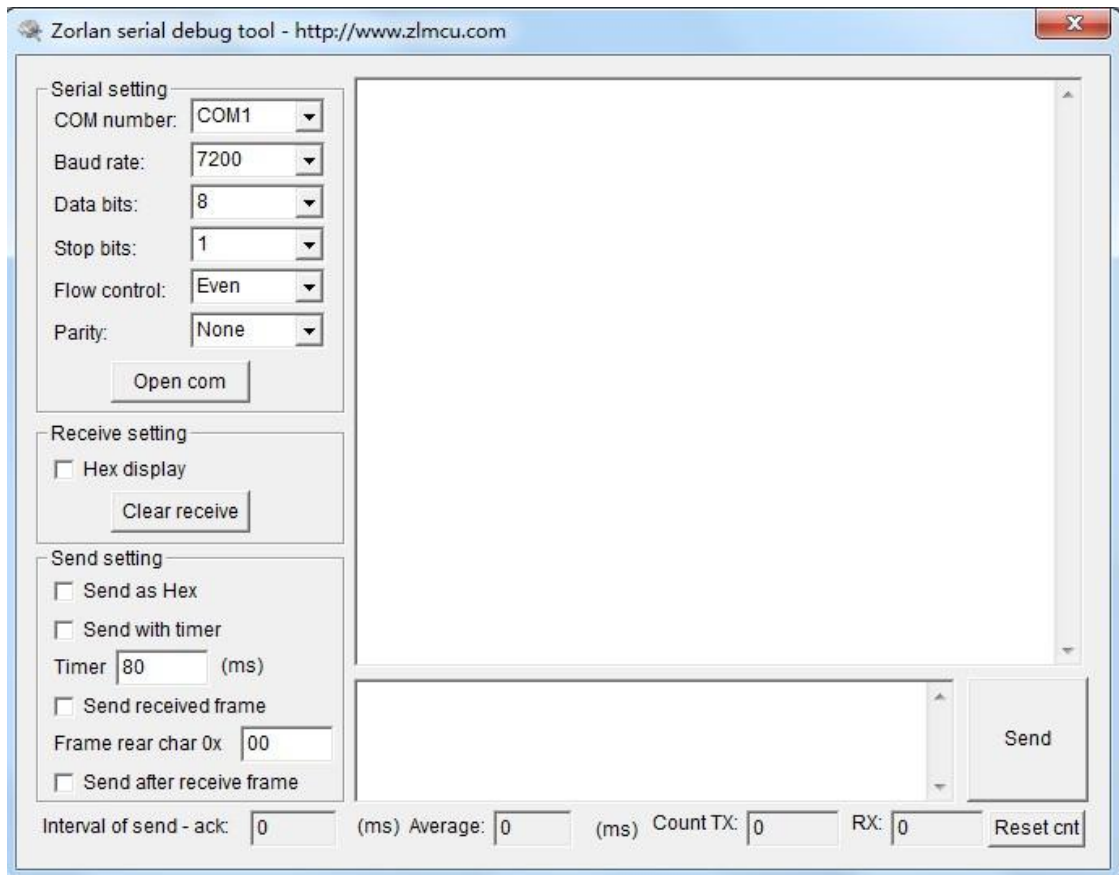

Figure 8 ComDebug Send-receive Interface

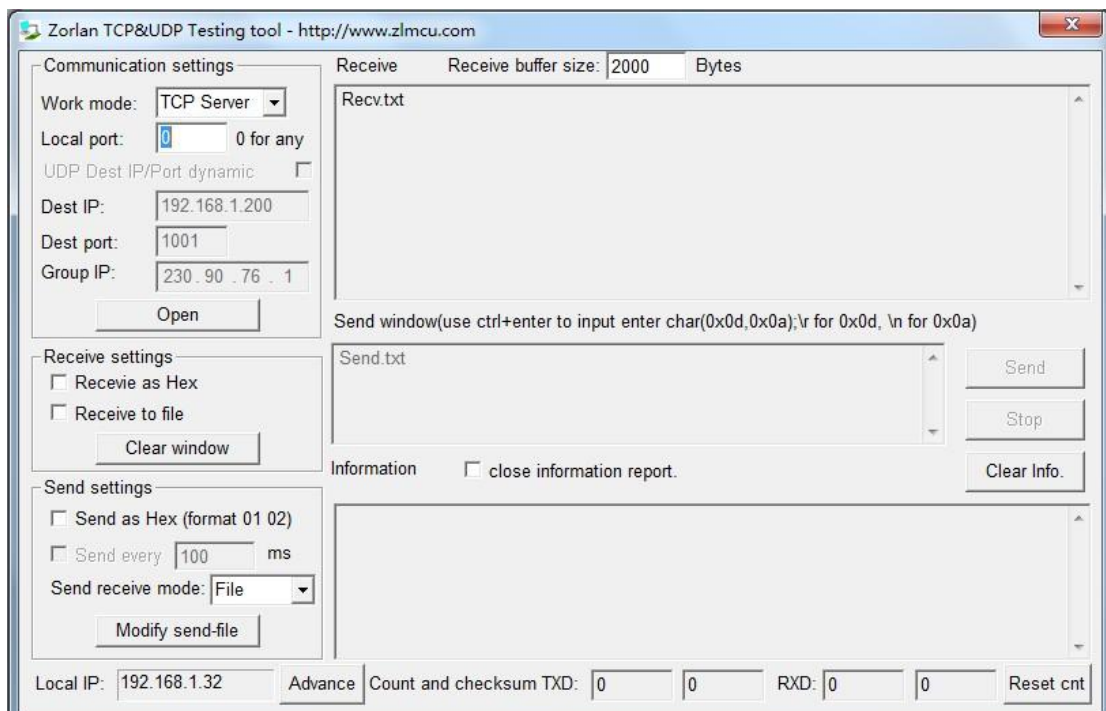

Figure 9 SocketTest Send-recv Interface

5.5 Virtual serial port test

SocketTest in figure 8 communicates directly with the serial port server through TCP. In order to enable users to communicate with the serial port server with the developed serial port software, it is necessary to add a virtual serial port between the user program and the serial port server. As shown in figure 10, ZLVircom and the user program run on a computer, and ZLVircom virtual a COM port, so that the COM port corresponds to the serial port server. When the user program opens the COM to communicate through ZLVircom → serial device server → to users. Here's how to do this:

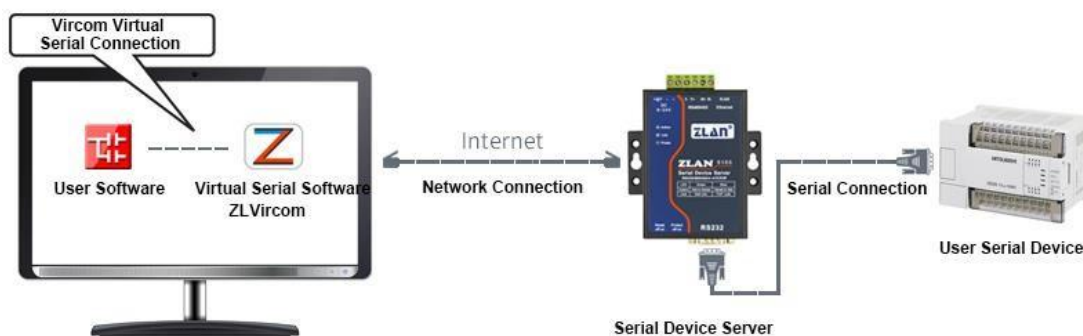

Figure 10 Virtual serial port

Click on the "Serial Manage" of the main interface of ZLVircom, then click "Add", and select COM5, where COM5 is the COM port that didn't exist on the computer.

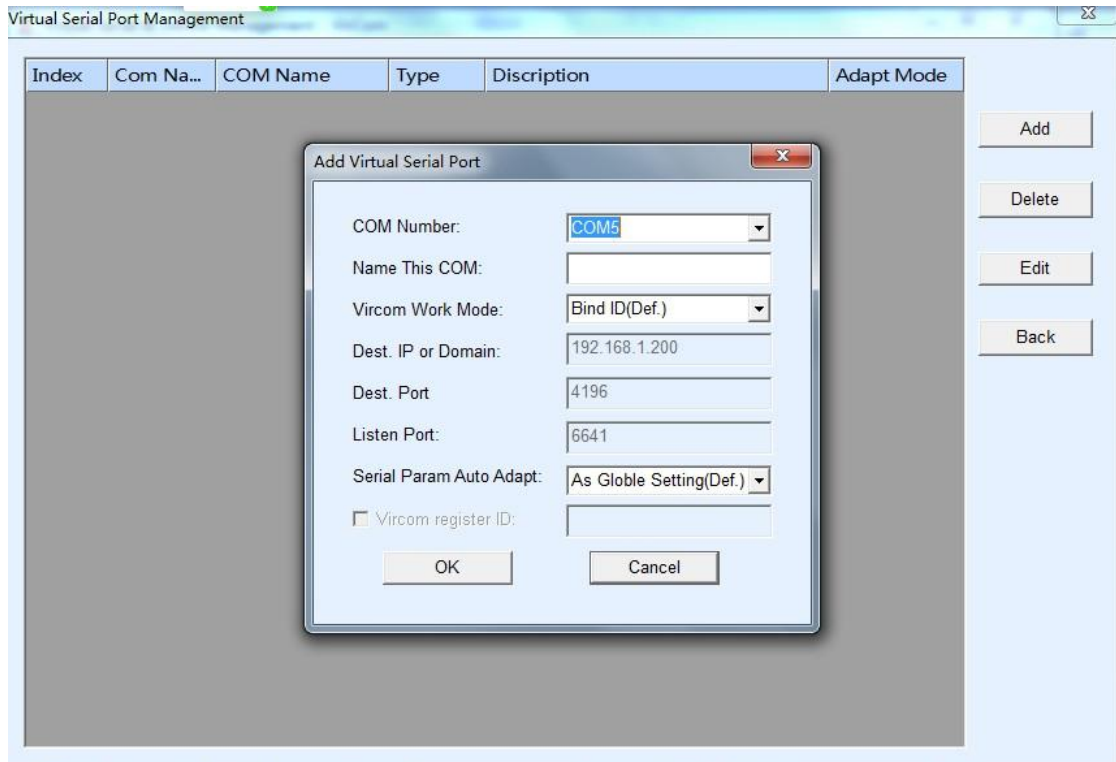

Figure 11 Add Virtual Serial Port

Then enter the “device manage”, and double-click the device that you need to bind to the COM5. As shown in FIG. 6, select COM5 from the "virtual serial port" list in the upper left corner. Then click "modify Settings". And return to the main interface of ZLVircom. You can see that the COM5 has been connected to a device with IP 192.168.1.200. You can use COM5 instead of SocketTest to communicate.

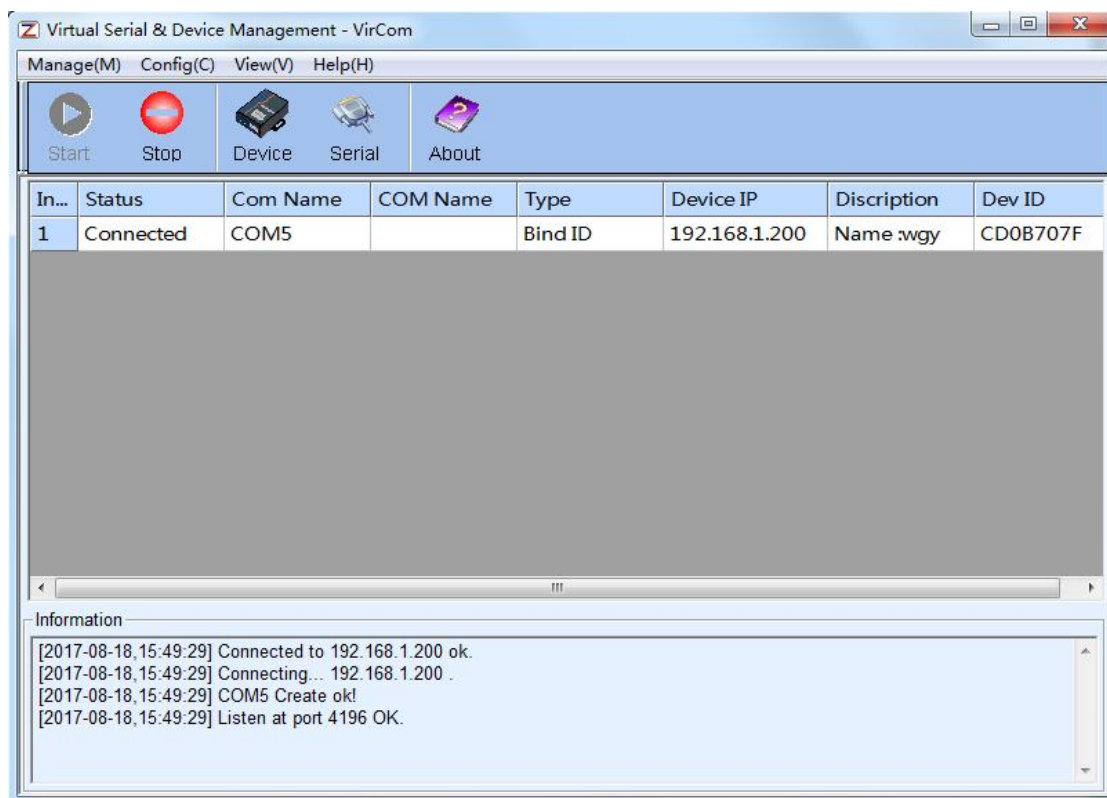

Figure 12 Virtual Serial Port has been connected

Now close the before SocketTest and open a new ZLComdebug as the user's serial port program, now open COM5. At this point, COM5 (virtual serial port) and COM4 (hardware serial port) can send-receive data through networking products. If the serial port of the connected product is not connected to the COM port of PC, but a serial port device, then the COM5 can be opened to communicate with the device. And it's just use the network way now.

Open ZLComdebug to simulate the user's serial port program, open COM5 (virtual serial port above), open another ZLComdebug to simulate a serial port device, and open COM4 (hardware serial port). At this point, COM5 sends the data link as follows: ZLVircom→Serial server network port→Serial port server serial port→COM4. Conversely, COM4 to COM5 can also transmit data: COM4→Serial port server serial port→Serial server network port→ZLVircom→COM5. As shown in figure 13, both parties send and receive data.

If COM4 is replaced by a user serial device, COM5 can communicate with the user device.

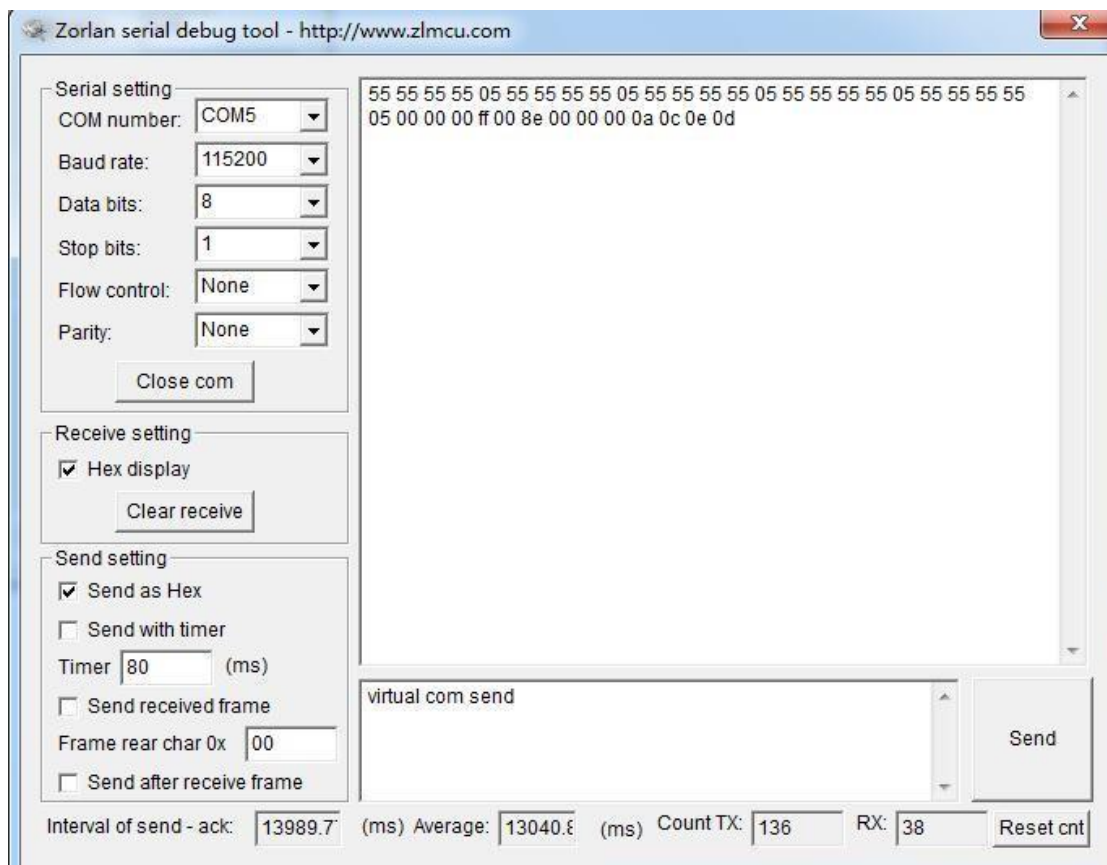
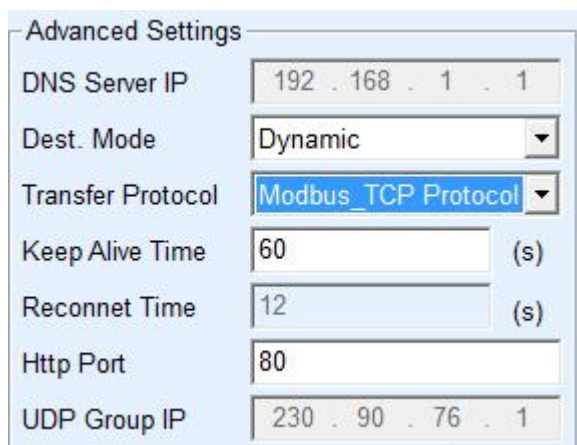

Figure 13 Communication via Virtual Serial Port

5.6 Modbus TCP test

By default, serial and network data is transmitted transparently. If you need to implement the Modbus TCP to RTU, requires selecting "transfer protocol" for "Modbus TCP \leftrightarrow RTU" in the Settings dialog, as shown in figure 14. At this point, the device port is automatically changed to 502. At this point, the user's Modbus TCP tool is connected to port 502 of IP of serial port server, and the Modbus TCP instruction sent will be converted into RTU instruction output from the serial port. For example, the serial port server network port receives the Modbus TCP instruction of 00 00 00 00 00 6 01 03 00 00 0a, then the serial port outputs the instruction of 01 03 00 00 00 0a c5 cd. Note: the serial port may send several 01 03 00 00 00 0a c5 cd instructions, because the default Modbus adopts the storage mode, which will automatically poll to query. It'll show you how to switch to non-storage.



The screenshot shows the 'Advanced Settings' window with the following configuration:

Field	Value
DNS Server IP	192 . 168 . 1 . 1
Dest. Mode	Dynamic
Transfer Protocol	Modbus_TCP Protocol
Keep Alive Time	60 (s)
Reconnet Time	12 (s)
Http Port	80
UDP Group IP	230 . 90 . 76 . 1

Figure 14 Enable Modbus TCP

If the user's Modbus TCP software is used as Slave, it is necessary to change the working mode to client based on the transfer protocol selection, and the destination IP change to the computer IP of Modbus TCP software, and the destination port is 502, as shown in figure 15.

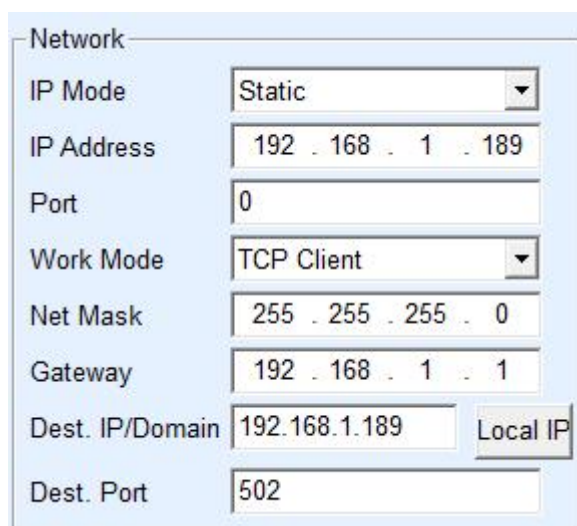

The screenshot shows the 'Network' window with the following configuration:

Field	Value
IP Mode	Static
IP Address	192 . 168 . 1 . 189
Port	0
Work Mode	TCP Client
Net Mask	255 . 255 . 255 . 0
Gateway	192 . 168 . 1 . 1
Dest. IP/Domain	192.168.1.189 Local IP
Dest. Port	502

Figure 15 Modbus TCP as Client

6. Work Mode and Transfer Protocol

In different applications can choose different work mode, transfer protocol of the serial server, so as to be more stable and reliable use, the details are as following.

The use of serial device server is basically divided into two types: with virtual serial port and non-virtual serial port, as shown in fig.7 TCP communication diagram and fig.10

function of virtual serial port. The user software with virtual serial port needs to be connected is the COM port, that is, both the user software and the user device are serial ports. Non-virtual serial mode user software communicates directly over TCP/IP but user devices are still serial.

In the non-virtual serial port mode, the "Transfer Protocol" is divided into transparent transmission, Modbus TCP to RTU and Realcom protocol. If the user software is a fixed Modbus TCP protocol and the host computer is Modbus RTU, Modbus TCP to RTU mode should be selected. The Realcom protocol is currently only used when a multi-port server is connected to a server as a TCP client and a virtual serial port is used on the server.

Usage is summarized as follows:

Table 4 network configuration modes

No.	Virtual Serial Port Usage	Device Work Mode	Transfer Protocol	Instructions
1	Use	TCP Server	None	Suitable for the user to open the COM port to collect data actively.
2	Use	TCP Client	None	Suitable for the occasion when the device sends data actively. If the TCP server is selected, the problem that the device cannot be reconnected after being disconnected may occur.
3	No Use	TCP Server	Modbus TCP to RTU	The user software is Modbus TCP, and the user device is Modbus RTU. Modbus TCP is the main station.
4	No Use	TCP Client	Modbus TCP to RTU	The user software is Modbus TCP, and the user device is Modbus RTU. And Modbus RTU is the main station.
5	Use	TCP Client	Realcom Protocol	When using a multi-port server as a TCP client and the virtual serial port is used, it is best to use the Realcom protocol.
6	No Use	TCP Client	None	Suitable for a large number of devices, connected to a cloud way. And under normal circumstances the cloud is a server of public network IP on the Internet.
7	No Use	TCP	None	Suitable for devices and computers in

		Server		the same local network, do local monitoring, no need to communicate across the Internet.
--	--	--------	--	--

6.1 Virtual Serial Mode

If the user software is using COM port for communication, it must use virtual serial port mode. Including some PLC software, configuration software, instrument software, etc.

Then check whether the monitoring computer and equipment are in the local network:

- 1) If the computer is a public network IP server rented over the Internet, then the device must use TCP client mode to connect the device to the server. At this point, you can select the (2) and (5) in Table 4, and must select (5) if it is a multi-port server.
- 2) All in the local network (can ping each other), then see is the upper computer active query or device active send data. If the device is sent initiatively it must use the device to be TCP client as (2) in Table 5, or you can choose the (1) way.

6.2 Direct TCP/IP Communication Mode

If Modbus TCP conversion is not required and virtual serial port is not required, the user software may directly communicate with the network port of the serial port server for TCP/IP communication, and the serial port server will transfer the TCP/IP data to the serial port data and send it to the serial port device.

Generally, users of this kind of usage develop the network communication software of upper computer by themselves and integrate the analysis of the serial communication protocol of the equipment. This method is more flexible and efficient than virtual serial port. Correspond to (6) and (7) in table 6.

In the section of "6.4 TCP Communication Test", it mainly introduces how to communicate when the serial port server is a TCP server. Here you will learn about TCP clients, UDP mode, and how multi-TCP connections communicate with computer

software. The computer software takes SocketTest (the software that imitates the user's TCP/IP to communicate) as an example.

ZLAN serial port server is in compliance with the standard TCP/IP protocol, so any network terminal that conforms to the protocol can communicate with the serial port server. ZLAN technology provides the network debugging tool (SocketDlgTest program) to simulate the network terminal to communicate with the serial port server.

For two network terminals (in this case, the network debugging tool and the serial port server) to be able to communicate, the configuration of the parameters must be matched.

6.2.1 TCP Client Mode

There are two operating modes under TCP mode: TCP Server and TCP Client. No matter which mode is adopted, one side must be the Server side and the other side the Client side. Then the Client side can access the Server side.

When the serial port server is the Client, there must be three corresponding relationships, as shown in figure 16. 1) working mode correspondence: the working mode of the serial port server is the Server mode corresponding to the Client mode of the network tool; 2) IP address correspondence: the destination IP of the serial port server must be the IP address of the computer on which the network tool is located; (3) port correspondence: the destination port of the serial port server must be the local port of the network tool. In this way, the serial port server can automatically connect to the network tools, send and receive data after the connection is established.

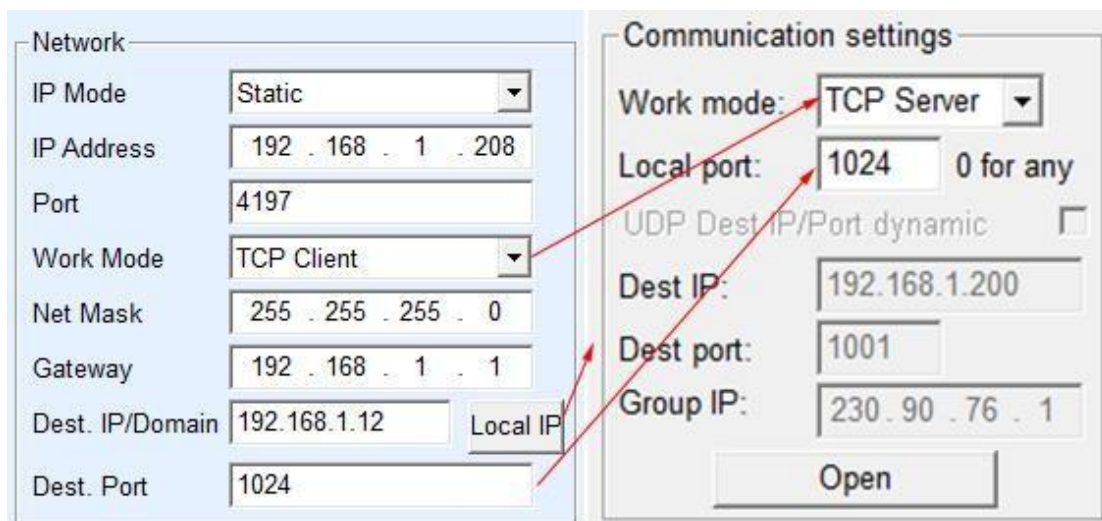

Figure 16 The serial port server as the Client

6.2.2 TCP Server Mode

When the serial port server acts as a Server, there are also three corresponding relationships, as shown in figure 17. There is no explanation here. After this setting, click the open button of the network tool to establish a TCP connection with the serial port server, send and receive data after the connection is established.

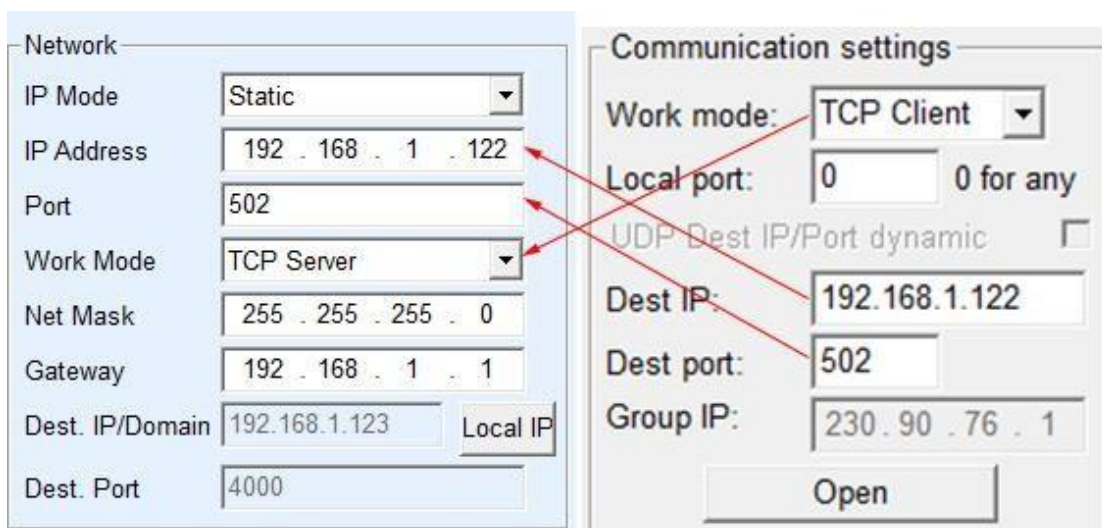

Figure 17 The serial port server as the Server

When the serial server is as Server, it can accept 30 TCP connections simultaneously. The data received by the serial port is forwarded to all

established TCP connections. If the data need to be sent only to TCP that has recently received network packets, multi-host function needs to be enabled. Please refer to “8.2 Multi-host Function”.

6.2.3 UDP Mode

In UDP mode, the parameter configuration is shown in figure 18. The left side is the configuration of the serial port server in ZLVircom, and the right side is the setting of the network debugging tool SocketDlgTest. First, both must be UDP working modes. In addition, as indicated by the red arrow, the destination IP and destination port of the network tool must point to the local IP and port of the serial server. As indicated by the blue arrow, the destination IP of the serial port server must be the IP address of the computer where the network tool is located, while the destination port of the serial port server must be the local port of the network debugging tool. Only when these network parameters are configured the two-way UDP data communication can be guaranteed.

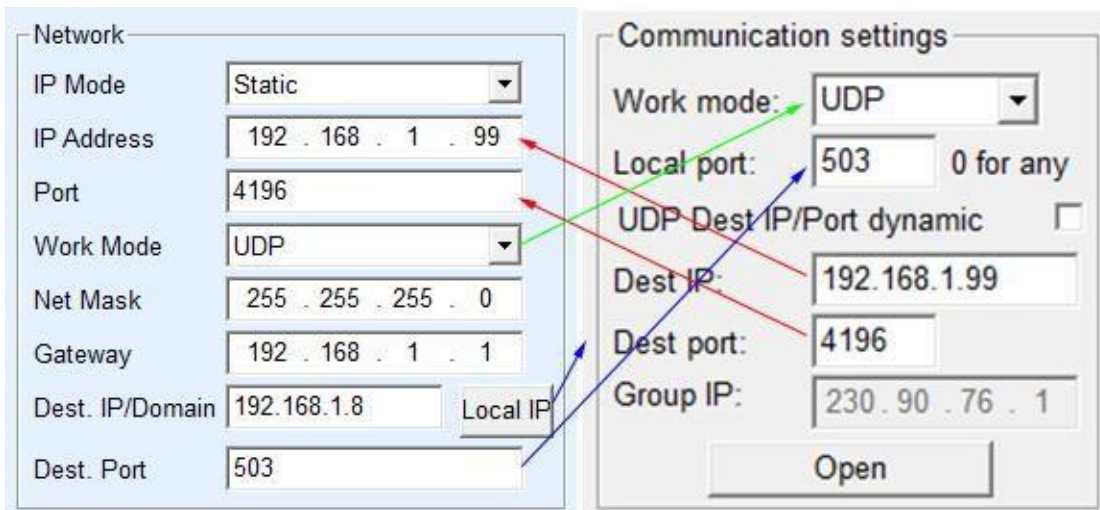

Figure 18 UDP mode parameter configuration

6.3 Device Pairs-connect Mode

If the upper machine is not a Socket program (SocketDlgTest) or a virtual serial port, but two devices are connected through a network port, the configuration method is similar. First, the user needs to connect two devices and computers to the same LAN.

ZLVircom runs on this computer and is only connected to the computer for configuration purposes, after which the computer does not need to be connected.

Click ZLVircom's device management to find the two devices, as shown in figure 20. Then click "Device Edit" to configure the device. Device pair-connection can be divided into TCP pair and UDP pair. In the case of TCP pairing, the parameters of the two devices are shown in figure 19. The parameters shown by the arrows must correspond as if they were connected to a PC. After a successful TCP connection, you can view the connection status by going back to the device management dialog box, as shown in figure 20. If both devices are "connected", the TCP link for both devices has been established.

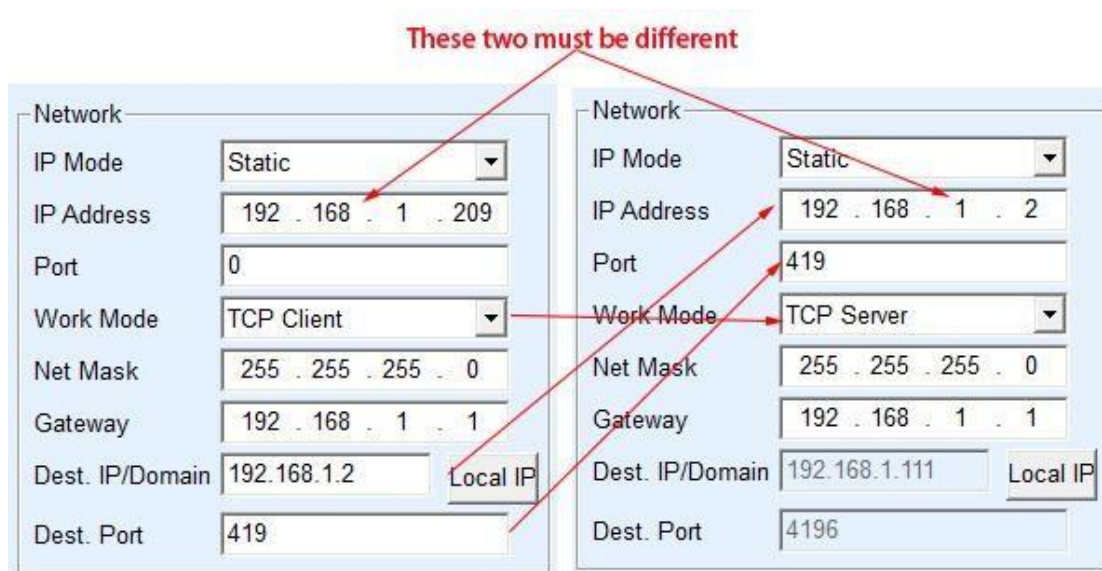

Figure 19 TCP device pairing parameter configuration

In...	Ty...	Name	I	Dev IP	Dest IP	Work M...	TCP ...	Virtual ...	Vircom St...	Dev ID	TXD	RXD	
1	Su...	LYH		192.168.1.2	192.168.1.3	TCP Ser...	Estab...	Haven't ...	Not Linked	B8AC6D4F	0	0	
2	Su...	LYH		192.168.1.209	192.168.1.2	TCP Clie...	Estab...	Haven't ...	Not Linked	B7F74C2A	0	0	Auto Search

Figure 20 successful TCP device pairing check

In the case of UDP pair-connection, the configuration parameters are shown in figure 21, and the parameters corresponding to the arrows must be one-to-one. As long as the parameters of UDP pair are configured correctly and the connection status is not checked, the data sent will be automatically sent to the specified device.

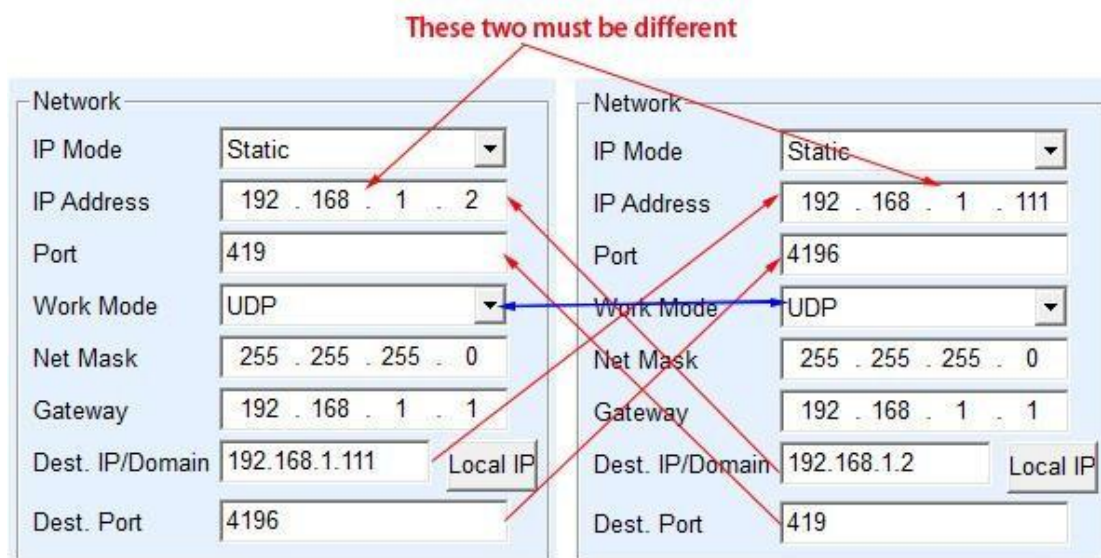

FIG. 21 configuration of UDP device pairing parameters

Finally, we need to remind that if the device is connected to each other, in addition to the above settings of the Ethernet port parameters, the serial port parameters must also be correctly set. Mainly is the serial port server baud rate and so on needs to be consistent with user's equipment baud rate and so on. With this setup, the user device can send data to each other through the serial ports of the two serial servers.

7. Device Debugging

7.1 Network Physical Connection

The serial server can connect to the 10M/100M switch or connect directly to the computer network port by using a cross or direct network cable.

The first step after the connection established is to check whether the Link light is green, otherwise, please check whether the network cable is connected well.

7.2 Network TCP Connection

When the device is in dynamic accessing IP mode, cannot directly connect to the computer network interface. Because no have DHCP server to be able to use (general DHCP server is the router in LAN). So please specify IP when connecting directly. The

computer also needs to specify a fixed IP address.

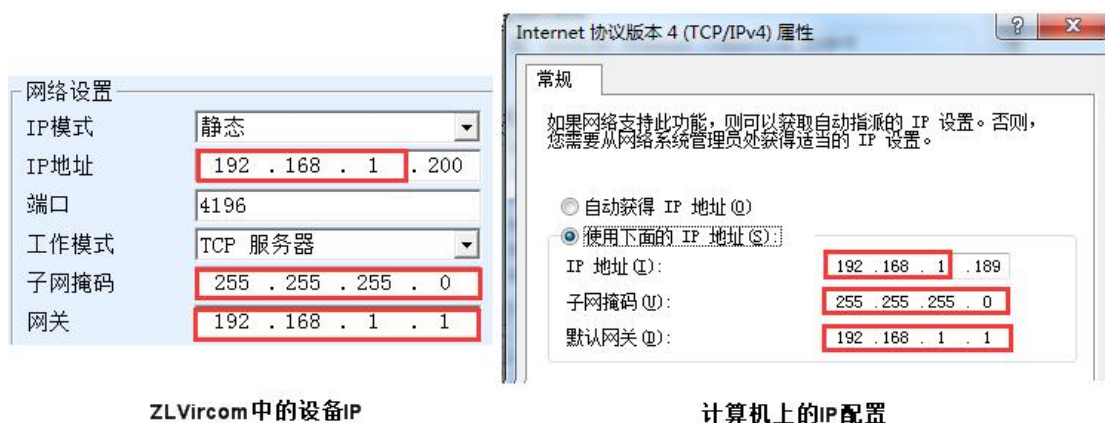

Figure 22 Configure on the same network segment

When configured with static IP, both the device and the computer need to be on the same network segment (unless communicating across gateways), either directly or through a switch, as shown in figure 22.

Since ZLVircom supports cross-segment search and configuration, the IP address that can be searched but cannot be communicated is usually not well configured. In this case, ZLVircom can be used to configure devices in the same network segment.

After the configuration, the Link light turns blue when the TCP connection is established by using the steps of "6.4 TCP Communication Test" or "6.5 Virtual Serial Port Test". The Link light blue can also be seen through ZLVircom, as in the device management list, if the TCP connection is listed as "established" then the Link light is blue, as shown in figure 23, which facilitates remote diagnosis.

Device Management											
In...	Ty...	Name	Dev IP	Dest IP	Work M...	TCP Conn...	Virtual ...	Vircom St...	Dev ID	TXD	RXD
1	Su...	ZLDEV00...	192.168.1.234	192.168.1.3	TCP Ser...	Established	Haven't ...	Not Linked	A10B...	45	1

Figure 23 Connection status and data send/receive status

7.3 Data Sending and Receiving

When the Link light turns blue, data can be sent and received between the software

and the serial port server. If the software sends a message, the Active light turns green for at least a second. The data is also output from the serial port server, but whether the output data is correct depends on whether the correct serial port parameters (baud rate, data bit, stop bit, check bit) are configured.

The serial device will reply to the right instruction. If there is a reply (the serial port sends data to the network port), "Active" will turn blue. Otherwise, please check the serial port parameters or the connection of the serial port line.

In order to facilitate remote debugging, ZLVircom also supports remote viewing of data sent and received, as shown in figure 23, where TXD is the amount of data sent by the serial port server. When refreshing the list of devices, a change in this value indicates that data has been sent, and the Active light is also green. If you see a change in the RXD value it indicates that the serial device has returned data. Active is blue.

7.4 ZLVircom Remotely Monitor Data

In the case of virtual serial port, ZLVircom supports real-time capture of data sent and received from the virtual serial port. It is convenient for users to debug the system. The use method is as follows:

It is assumed that the virtual serial port communication has been established according to the "5.5 Virtual Serial Port Test" method. Now you need to monitor the data passing through the virtual serial port. Open the ZLVircom menu/configuration/software configuration/open the vircom configuration dialog box.

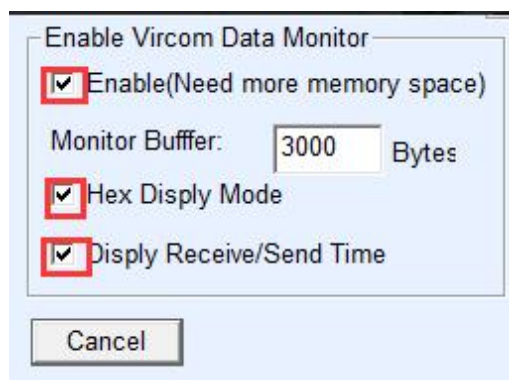

Figure 24 enabling ZLVirocm monitoring

Select the three options of enable monitoring, hexadecimal monitoring mode, and display the time of send-receive data, as shown in figure 24. Then click ok. Assuming that data has been sent and received before, now select a virtual serial port to be monitored in the main interface, and then select the menu/view/monitor, as shown in figure 25.

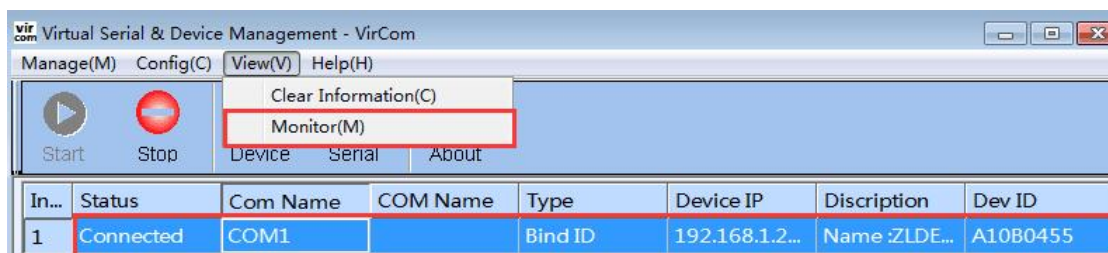

Figure 25 Open ZLVirocm monitoring

From the open dialog box, you can see the instructions issued by the upper computer and the instructions returned by the device, as shown in figure 26. This function can be convenient for field communication debugging.

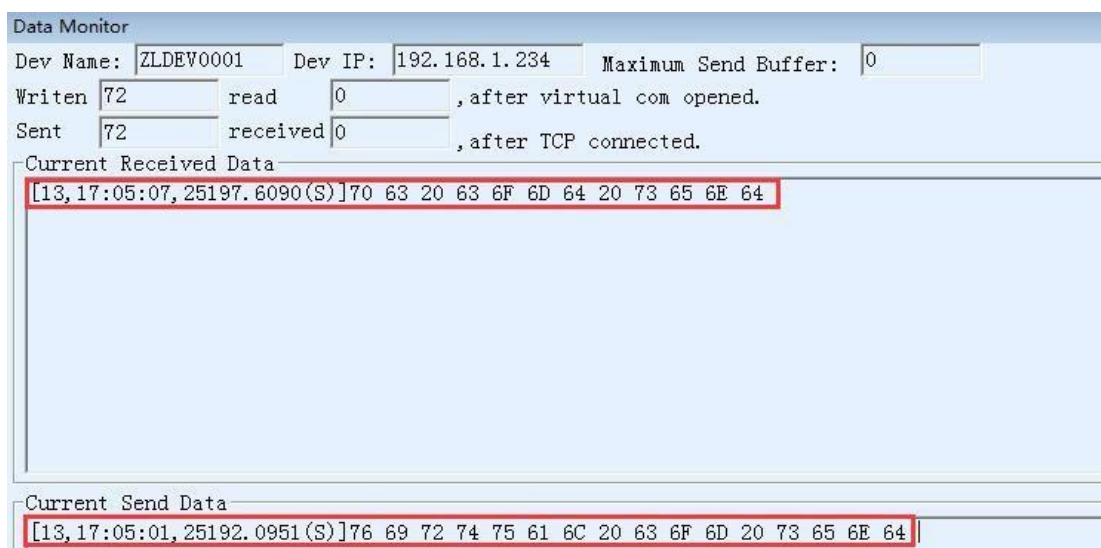

Figure 26 monitor send-receive data

8. Modbus Advanced Features

The serial port server with Modbus gateway function does not have station address and

register. It is a communication bridge. It will generate Modbus RTU designation according to Slave ID, function code, register No. and register number in Modbus TCP instructions sent to Modbus gateway by user software and output them from the serial port. Think of it as a protocol "translator."

8.1 Enable Modbus Gateway

First of all, the serial port server should support Modbus gateway, that is, the function of "Modbus TCP to RTU" supported by devices in table 5 in the device Settings dialog box should be checked.

By default, a serial port server is in ordinary transparent transmission mode, if you need to Modbus gateway pattern, please choose the option "Modbus TCP \leftrightarrow RTU" in the "transfer protocol". The device then automatically changes the "port" parameter to 502 (the Modbus server's port). The Modbus gateway is thus enabled.

If the serial port RTU device is the slave station, then the host computer Modbus TCP software connects to port 502 of Modbus gateway. At this time, Modbus gateway needs to work in TCP server mode. If the serial port RTU is the main station, the Modbus gateway works on the TCP client side, and the destination IP fills in the IP of the computer on which the Modbus TCP software resides, and the destination port is generally 502.

8.2 Multi-host Function

As shown in figure 28, "RS485 multi-host support" and "RS485 bus collision detection function" are ZLAN's multi-host functions. They are generally both enabled and disabled at the same time. After enabling, the device that converts the protocol into Modbus TCP has the function of storage Modbus gateway; otherwise, it is a non-storage Modbus gateway. If the conversion protocol is none, generally, the user-defined RS485 protocol can also have the function of serial devices accessed by multiple hosts at the same time, which cannot be achieved in the pure RS485 network, because the sending of multiple master stations at the same time will cause conflicts

on the RS485 bus. The multi-host of ZLAN serial port server can "coordinate" the RS485 bus so as to achieve the purpose of multi-host access.

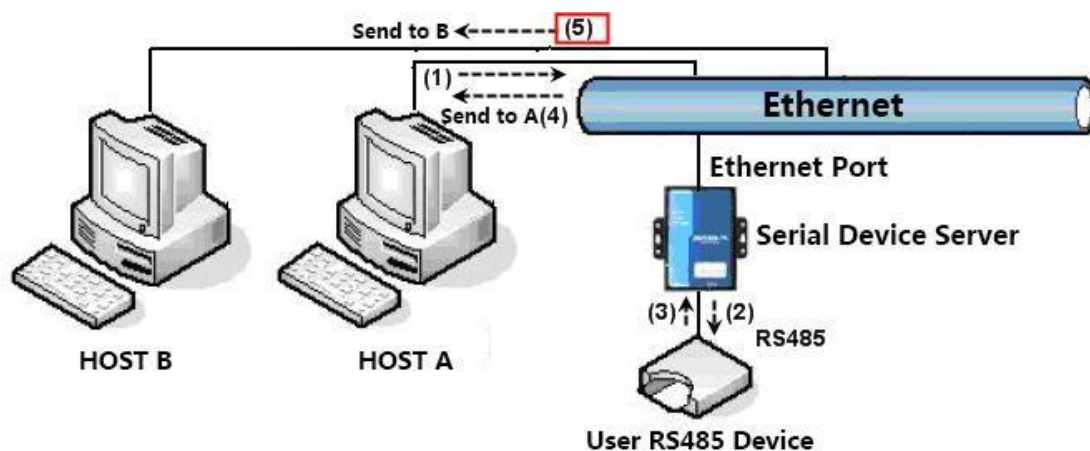

Figure 27 multi-host function demo

As shown in figure 27, in normal mode, when two hosts, host A and host B, are connected to the serial port server at the same time, host A sends (1) instruction, RS485 device receives (2) instruction, and RS485 device returns (3) instruction, but the serial port server sends (4) to host A and (5) to host B at the same time. Since host B did not send a query, but it also received a reply instruction (5), host B may generate a communication exception error. In the multi-host mode, only instructions (4) will be given and no instructions (5) will be given, because the serial port server will automatically remember the host that needs to be returned and only return the instructions to the nearest communication host. The query of host A will only reply to A, and the query of host B will reply to host B.

Another effect is that in normal mode, when host A and host B send data at the same time, the instruction combination will be generated on the RS485 bus, so that it cannot be recognized normally. In the multi-host mode, the serial port server can schedule the priority of A and B on the use bus, so as to solve the conflict problem of simultaneous access of multiple machines in an effective manner.

If the conversion protocol is "none", the default is not to enable multi-host function. If you need to enable multi-host, please click "more advanced options" in the device

configuration dialog box, and then check "RS485 multi-host support".

8.3 Multi-host Parameter

The meanings of "RS458 multi-host support" and "RS485 bus collision detection function" are described as follows.

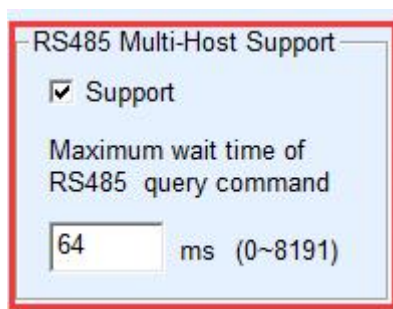

Figure 28 RS485 multi-host support

RS485 instruction reply timeout is: the maximum time interval between the start of sending this instruction and the receipt of the reply by the serial port server. The filling time should be greater than the actual maximum time interval. If the timeout is determined, the next instruction is sent.

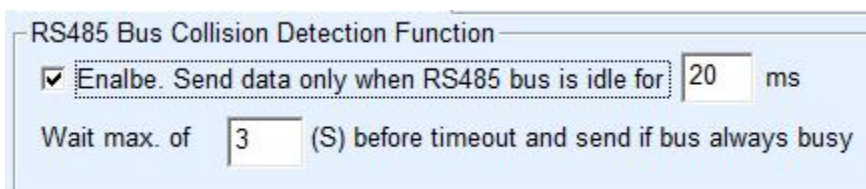

Figure 29 RS485 conflict free time

RS485 bus collision time: indicates how many milliseconds the serial server waits to send the second instruction after receiving the reply of the first instruction. This parameter actually defines the speed of instruction rotation. This value is recommended above 20ms. The "maximum wait time is 3 seconds" parameter does not need to be modified.

When the user use ZLVircom to select "Modbus TCP to RTU" as the transfer protocol, ZLVircom will automatically select the above two enabled boxes (unless the user manually enters the advanced option to remove), and the above two times will be

automatically configured according to baud rate. However, if the user's Modus instruction is relatively long or the conversion protocol is "none", these two parameters need to be manually configured.

The following is the recommended setting values of the above parameters:

- 1) Figure 29 shows the "RS485 bus anti-collision time", which can be set as twice of the "packet interval" in the lower right corner of the parameter configuration interface, but the minimum value should not be less than 20.
- 2) Figure 28 shows "RS485 instruction reply timeout time", which is generally determined according to the length of the reply instruction. If the sending instruction is N bytes and the reply is M bytes, the recommended value is: "packet interval" * (N+M+5) +100.

9. Network Interface to Modify Parameters

Network interface modification parameter is a function to search and modify device parameters like zlvircom software, that is, to manage the device and modify parameters through the network interface of the serial port server. Suitable for users who integrate search and configuration functions into the user's software.

Network interface modification parameters are realized through "UDP management port protocol", such as:

- 1) Computer software sends UDP broadcast packets with destination port of 1092 in the network. When the device receives the data packet, it will return its information to the computer software to achieve the purpose of searching the device.
- 2) The computer software sends the UDP modification parameter command to the 1092 port of the device to achieve the purpose of modifying the device parameter.

The detailed introduction of network interface modification parameters can be referred

to the document of "UDP Management Port Protocol of ZLAN Networking Product". It can also be implemented directly using the device management function library of the "10 Device Management Function Library".

10. Device Management Function Library

This feature is suitable for users who need to integrate device management functions into their own software.

The described "UDP management port protocol" is integrated into the device management function library ZLDevManage. This is a Windows platform development library of DLL, can be called by VC, VB, Delphi and other development tools.

Provide detailed API interface introduction documents and VC call Demo case. Can realize the device search, parameter modification, P2P function call and so on.

Can be gained from ZLAN website development libraries: search for "equipment management function library" in <http://zlmcu.com/download.htm> pages. Please refer to "ZLAN WinP2p and equipment management development library" for details.

11. Serial Port Modify Parameters

Users can read and set parameters by sending instructions to the serial port of the serial port server. Suitable for users choose chip or module level products to control and configure through the serial port. Parameters that can be set include: IP address, baud rate, device name, working mode, etc. After setting the new parameters, you can restart the serial port server through the serial port instruction.

ZLAN serial instruction has the following characteristics:

- 1) The serial instruction uses 10 bytes of data leading code, so there is no need to distinguish the communication data or command through the pull down and pull up of another configuration pin, and there is no need to switch the command mode and communication mode, which is more flexible and convenient to use.

- 2) The command set contains a variety of command formats such as save parameters, do not save parameters, restart devices, and so on.
- 3) Can achieve a variety of applications, such as reading the MAC address of the serial port server, such as changing the working mode of the serial port server when switching from TCP Server to TCP Client mode, can actively connect to the server; You can disconnect from the TCP server when switching from the TCP Client to the TCP Server.

Please refer to “Serial port modification parameters and hardware TCPIP protocol stack” for detailed operation methods.

12. Remote device management

The so-called remote device management refers to the maintenance and management of the device through ZLVircom software, including restarting the device, modifying parameters and upgrading firmware. This feature is suitable for users who manage devices through ZLVircom.

For ZLVircom software, the device can be managed remotely as long as it can be found in the device list. Remote management of equipment can be divided into the following situations:

- 1) Automatic search: under the same switch of the device and computer, whether in the same network segment or not, the method of ZLVircom on the computer search for devices are: ZLVircomsend broadcast query→All devices will reply their parameters to the ZLVircom tool after receiving the query. This method searches all devices at once.

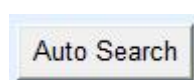

Figure 30 automatic search

- 2) Manual add: divided into two cases:

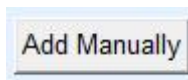

Figure 31 add manually

- a) Large routers split the network: in some large networks, the broadcast packets are split by the router so that the broadcast packets cannot reach the device, but pinging device IP is enabled. At this point, you generally need to manually add to solve. The method of manual addition is to click "manual addition" in the "device management" dialog box to add the first and last IP to query the devices one by one.
- b) Public network server query internal network equipment: the serial server in the internal network and as a TCP Server mode, zlvircom in the public network IP server. At this time, a port mapping of 1092 UDP should be made on the router of the network where the device is located, which is mapped to the IP of the device. Then, zlvircom will manually add the device, and the IP is the public network IP of the device.
- 3) TCP Client: when the device is a TCP Client, it initiates a TCP connection to port 4196 of the destination IP (116.15.2.3). When the connection is established, each hold time automatically sends its own parameter system to the UDP port (not TCP) on the destination port (4196 in this case,), enabling zlvircom to search for devices on this computer (116.15.2.3). If the destination port is not 4196, the default parameter receiving port of zlvircom needs to be modified by changing the menu/configuration/software configuration/default listening port, and then starting zlvircom will ignore the execution if TCP port conflict pops up.

Work Mode	TCP Client
Net Mask	255 . 255 . 255 . 0
Gateway	192 . 168 . 1 . 1
Dest. IP/Domain	116.15.2.3 Local IP
Dest. Port	4196

Figure 32 client

- 4) Timing sending parameters: even if the serial server is in the mode of TCP server, you can check the "timing sending parameters" function and send parameters to the destination port of the destination IP (in this case, 116.15.2.3) every 5 minutes. Zlvircom, which receives parameters on this port of the server, can manage these devices.

Work Mode	TCP Server	Keep Alive Time	60	(s)
Net Mask	255 . 255 . 255 . 0	Reconnet Time	12	(s)
Gateway	192 . 168 . 1 . 1	Http Port	80	
Dest. IP/Domain	116.15.2.3 Local IP	UDP Group IP	230 . 90 . 76 . 1	
Dest. Port	1024	<input type="checkbox"/> Register Pkt:		<input type="checkbox"/> ASCII
Serial		<input type="checkbox"/> Restart for no data	every 300	Sec.
Baud Rate	9600	<input checked="" type="checkbox"/> Enable send parameter	every 5	Min.

Figure 33 timing sending parameters

To facilitate device identification, give the device an easy-to-remember name if remote administration is required.

13. Cascade Method

The ZLAN5840I support cascades, which allows the ZLAN5840I to be easily expanded into 16-port, 24-port, and 32-port converters. Engineering transformation and upgrading are more convenient.

In cascading, the Uplink of the upper ZLAN5840I is connected to the ordinary port of

the lower ZLAN5840I (RJ45) using the manufacturer-supplied Ethernet cable (actually the shorter parallel cable). This cascade step can be continuously extended up to 8 levels.



Figure 34 ZLAN5840I cascade method

14. Installation Size

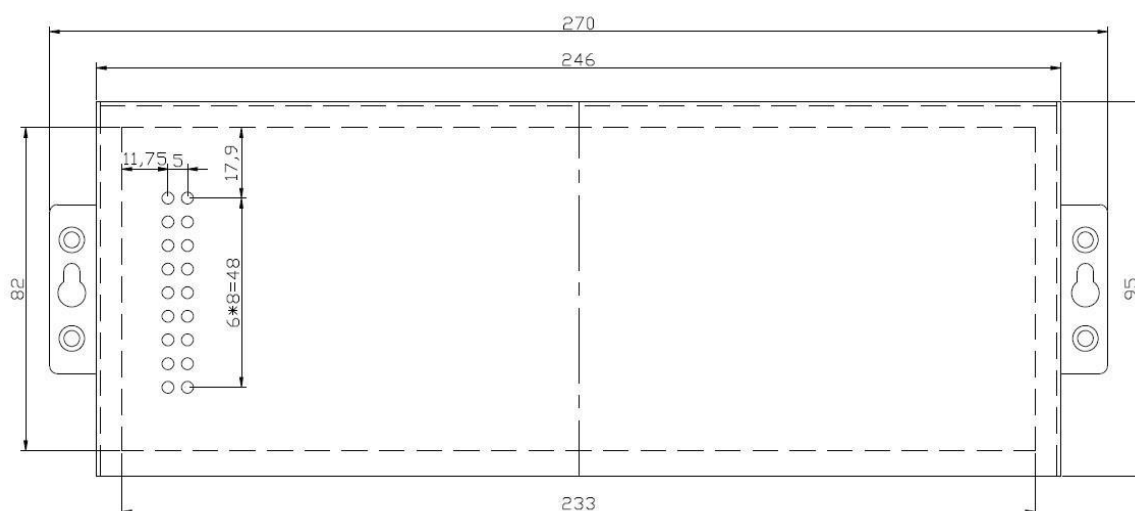

Figure 34 ZLAN5840I installation size

15. After-service and technical support

Shanghai ZLAN Information Technology Co., Ltd.

Address: 12 floor, D building, No. 80 CaoBao road, Xuhui District, Shanghai, China

Phone: 021-64325189

Fax: 021-64325200

Web: <http://www.zlmcu.com>

Email: support@zlmcu.com